

Trench Field-Stop Technology IGBT

Features

- 650V, 75A
- $V_{CE(sat)(typ.)} = 1.80V @ V_{GE} = 15V, I_C = 75A$
- Maximum Junction Temperature 175°C
- Pb-free Lead Plating; RoHS Compliant

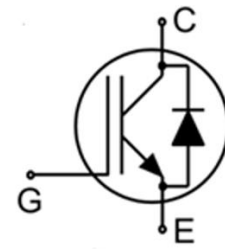

Applications

- Solar Converters
- Uninterrupted Power Supply
- Welding Converters
- Mid to High Range Switching Frequency Converters



Key Performance and Package Parameters

Order codes	V_{CE}	I_C	$V_{CEsat}, T_{vj}=25^{\circ}C$	T_{vjmax}	Marking	Package
XD075H065CX1S3	650V	75A	1.80V	175°C	D75H65CX1	TO247-3L

Absolute Maximum Ratings

Symbol	Parameter	Value	Unit
V_{CES}	Collector-Emitter Voltage	650	V
V_{GES}	Gate-Emitter Voltage	± 20	V
I_C	Continuous Collector Current ($T_C=25^{\circ}C$)	110	A
	Continuous Collector Current ($T_C=100^{\circ}C$)	75	A
I_{CM}	Pulsed Collector Current (Note 1)	300	A
I_F	Diode Forward Current ($T_C=25^{\circ}C$)	110	A
	Diode Forward Current ($T_C=100^{\circ}C$)	75	A
P_D	Maximum Power Dissipation ($T_C=25^{\circ}C$)	385	W
	Maximum Power Dissipation ($T_C=100^{\circ}C$)	192	W
T_J	Operating Junction Temperature Range	-40 to 175	°C
T_{STG}	Storage Temperature Range	-55 to 150	°C

Thermal Data

Symbol	Parameter	Max.	Unit
$R_{\theta JC}$	Thermal Resistance, Junction to Case for IGBT	0.39	°C/W
$R_{\theta JC}$	Thermal Resistance, Junction to Case for Diode	0.41	°C/W
$R_{\theta JA}$	Thermal Resistance, Junction to Ambient	40	°C/W

Electrical Characteristics ($T_c=25^\circ\text{C}$ unless otherwise noted.)

Symbol	Parameter	Conditions	Min.	Typ.	Max.	Unit	
BV_{CES}	Collector-Emitter Breakdown Voltage	$V_{GE}=0V, I_C=200\mu A$	650	---	---	V	
I_{CES}	Collector-Emitter Leakage Current	$V_{CE}=650V, V_{GE}=0V$	---	---	75	μA	
I_{GES}	Gate Leakage Current, Forward	$V_{GE}=20V, V_{CE}=0V$	---	---	100	nA	
	Gate Leakage Current, Reverse	$V_{GE}=-20V, V_{CE}=0V$	---	---	100	nA	
$V_{GE(th)}$	Gate Threshold Voltage	$V_{GE}=V_{CE}, I_C=750\mu A$	3.2	4	4.8	V	
$V_{CE(sat)}$	Collector-Emitter Saturation Voltage	$V_{GE}=15V, I_C=75A, T_j=25^\circ\text{C}$	---	1.80	2.20	V	
		$V_{GE}=15V, I_C=75A, T_j=125^\circ\text{C}$	---	2.05	---	V	
Q_G	Total Gate Charge	$V_{CC}=520V$	---	118	---	nC	
Q_{GE}	Gate-Emitter Charge	$V_{GE}=15V$	---	32	---	nC	
Q_{GC}	Gate-Collector Charge	$I_C=75A$	---	30	---	nC	
$t_{d(on)}$	Turn-on Delay Time	$V_{CC}=400V$ $V_{GE}=\pm 15V$ $I_C=75A$ $R_G=8\Omega$ Inductive Load $T_C=25^\circ\text{C}$	---	32	---	ns	
t_r	Turn-on Rise Time		---	91	---	ns	
$t_{d(off)}$	Turn-off Delay Time		---	152	---	ns	
t_f	Turn-off Fall Time		---	129	---	ns	
E_{on}	Turn-on Switching Loss		---	1.88	---	mJ	
E_{off}	Turn-off Switching Loss		---	2.43	---	mJ	
E_{ts}	Total Switching Loss		---	4.31	---	mJ	
C_{ies}	Input Capacitance		$V_{CE}=25V$	---	3781	---	pF
C_{oes}	Output Capacitance		$V_{GE}=0V$	---	355	---	pF
C_{res}	Reverse Transfer Capacitance		$f=1\text{MHz}$	---	38	---	pF
SCSOA	Short Circuit Safe Operation Area	$V_{GE}=15V, V_{CC}\leq 400V,$ $T_{J,start}\leq 25^\circ\text{C}$	5	---	---	μS	

Diode Characteristics ($T_C=25^{\circ}C$ unless otherwise noted)

Symbol	Parameter	Conditions	Min.	Typ.	Max.	Unit
V_F	Diode Forward Voltage	$I_F=75A, T_j=25^{\circ}C$	---	1.80	2.2	V
		$I_F=75A, T_j=150^{\circ}C$	---	1.65	---	V
t_{rr}	Diode Reverse Recovery Time	$V_R=400V$	---	136	---	ns
I_{rr}	Diode peak Reverse Recovery Current	$I_F=75A$ $di_F/dt=500A/us$	---	14	---	A
Q_{rr}	Diode Reverse Recovery Charge	$T_C=25^{\circ}C$	---	1.2	---	μC

Note1: Repetitive rating, pulse width limited by maximum junction temperature

Typical Characteristics

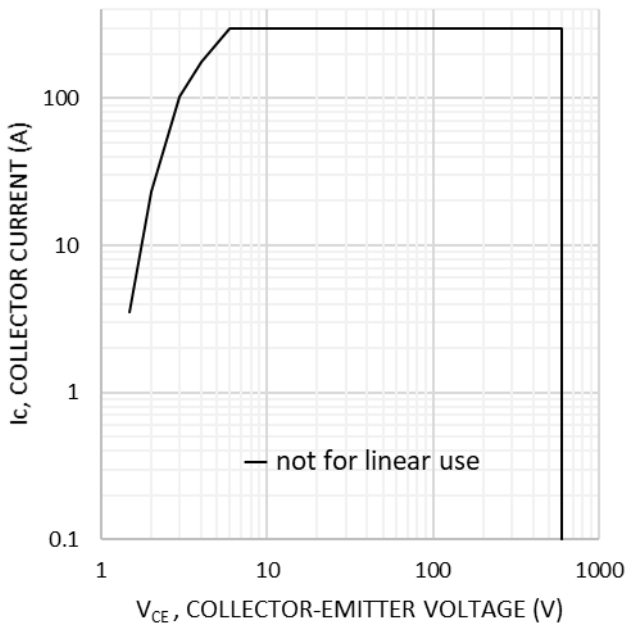

Fig. 1 Forward bias safe operating area (D=0, $T_c=25^\circ\text{C}$, $T_{vj}\leq 175^\circ\text{C}$; $V_{GE}=15\text{V}$. Recommended use at $V_{GE}\geq 7.5\text{V}$)

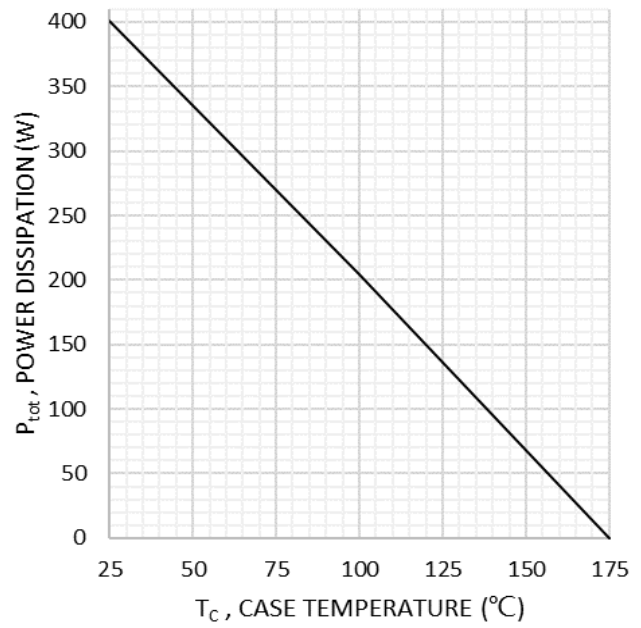

Fig. 2 Power dissipation as a function of case temperature ($T_{vj}\leq 175^\circ\text{C}$)

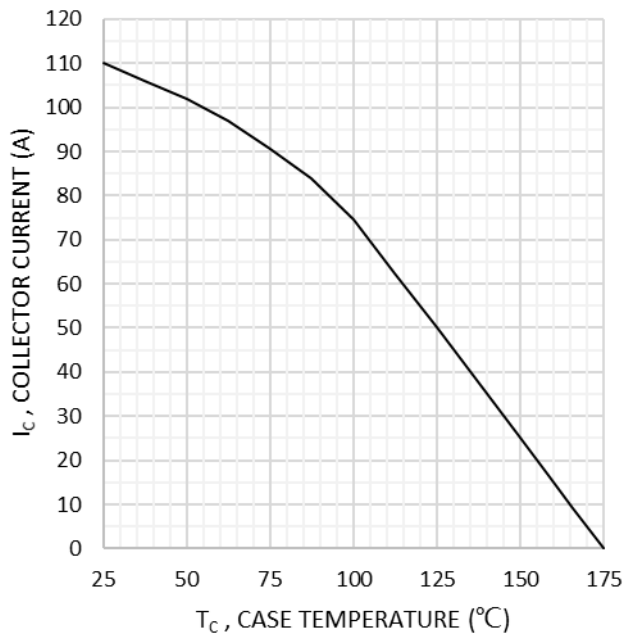

Fig. 3 Collector current as a function of case temperature ($V_{GE}\geq 15\text{V}$, $T_{vj}\leq 175^\circ\text{C}$)

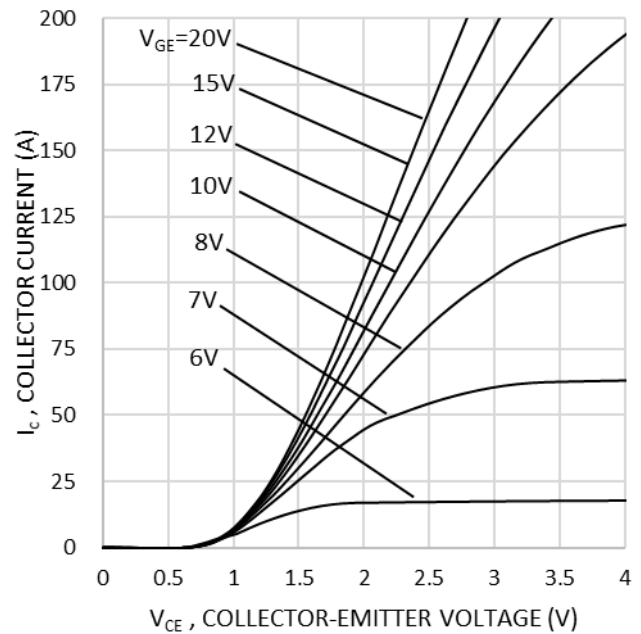

Fig. 4 Typical output characteristic ($T_{vj}=25^\circ\text{C}$)

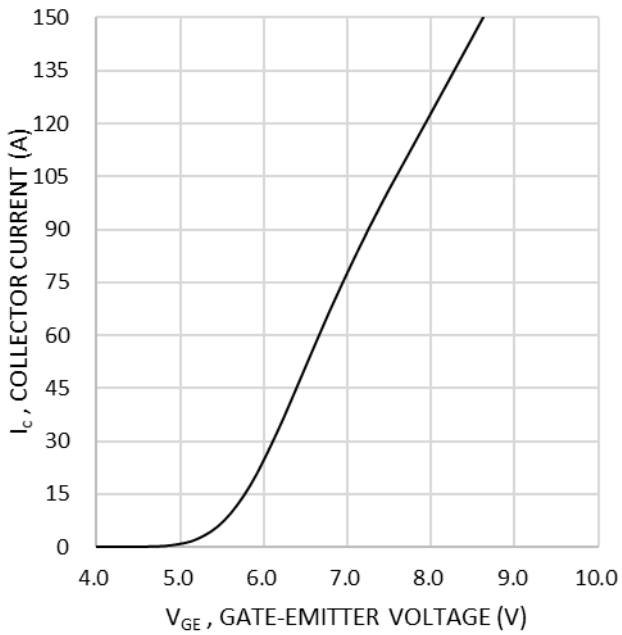

Fig. 5 Typical transfer characteristics ($V_{CE}=20V$)

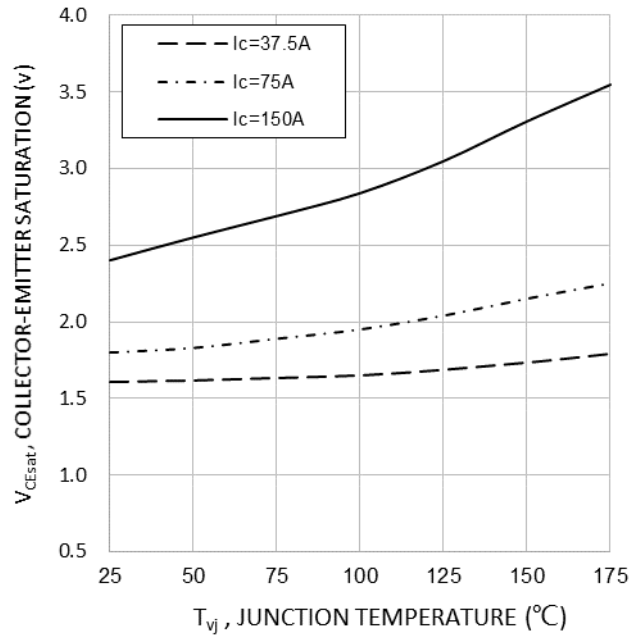

Fig. 6 Typical collector-emitter saturation voltage as a function of junction temperature ($V_{GE}=15V$)

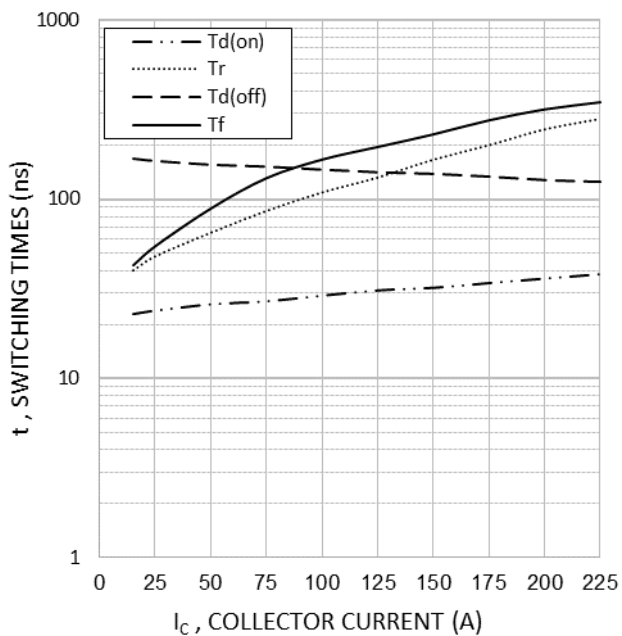

Fig. 7 Typical switching times as a function of collector current (inductive load, $T_{yj}=25^{\circ}C$, $V_{CE}=400V$, $V_{GE}=15/0V$, $r_G=8\Omega$)

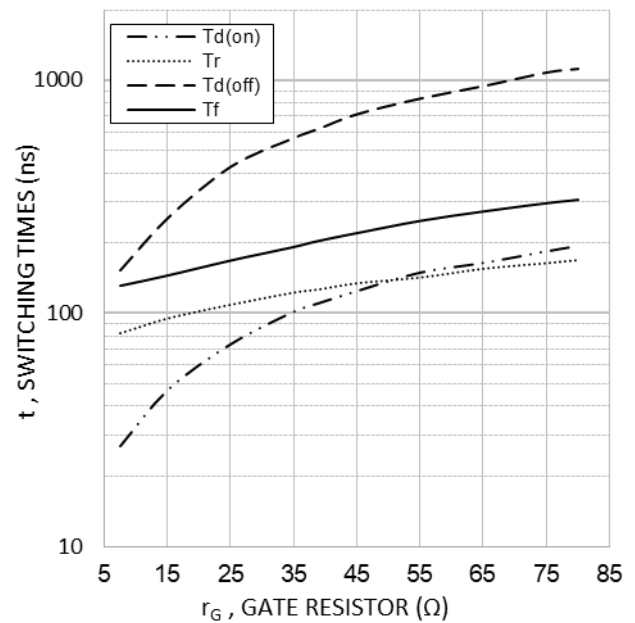

Fig. 8 Typical switching times as a function of gate resistance (inductive load, $T_{yj}=25^{\circ}C$, $V_{CE}=400V$, $V_{GE}=15/0V$, $I_C=75A$)

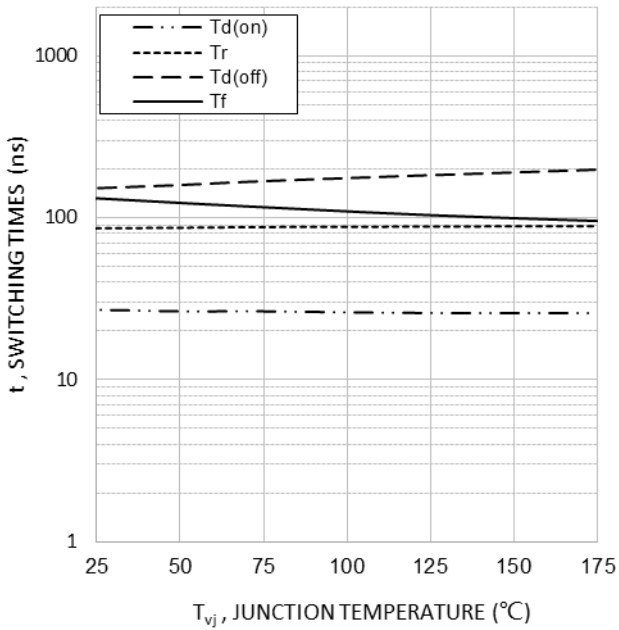

Fig. 9 Typical switching times as a function of junction temperature (inductive load, $V_{CE}=400V$, $V_{GE}=15/0V$, $I_C=75A$, $r_G=8\Omega$)

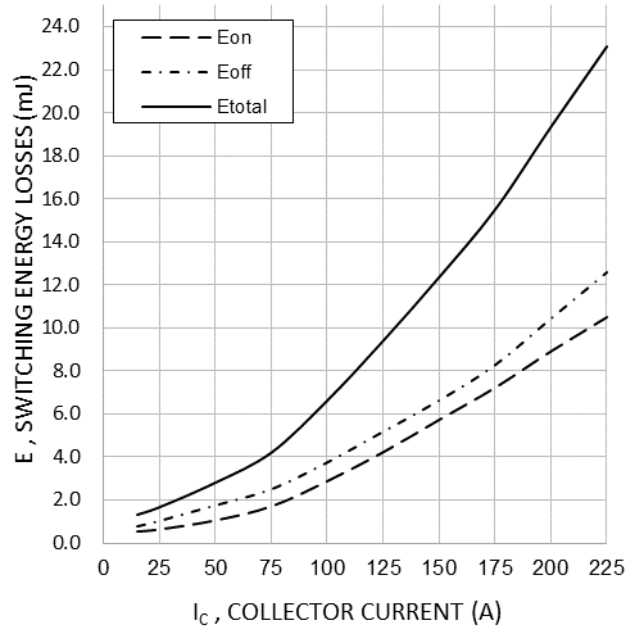

Fig. 10 Typical switching energy losses as a function of collector current (inductive load, $T_{jy}=25^\circ C$, $V_{CE}=400V$, $V_{GE}=15/0V$, $r_G=8\Omega$)

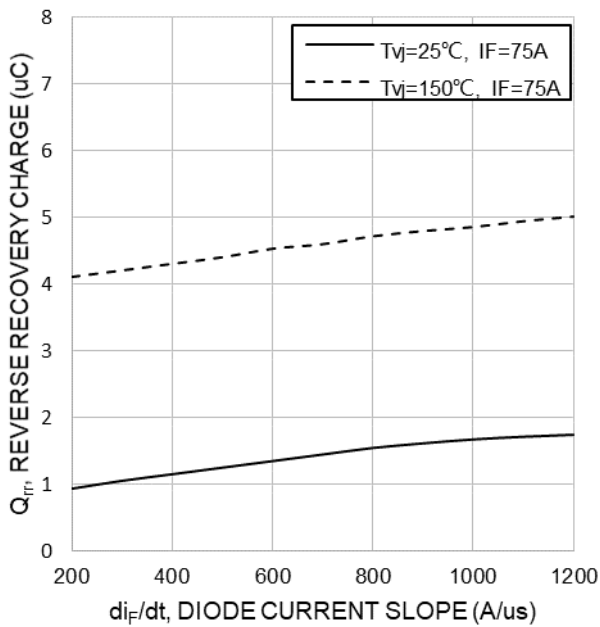

Fig. 11 Typical reverse recovery charge as a function of diode current slope ($V_R=400V$)

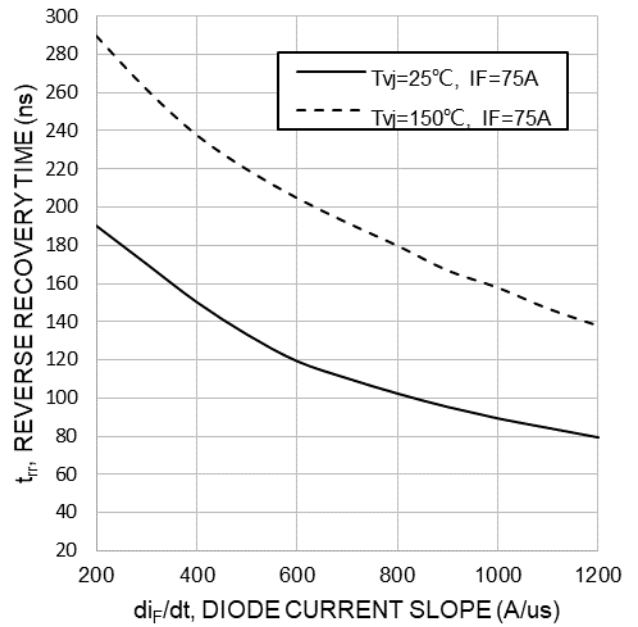

Fig. 12 Typical reverse recovery time as a function of diode current slope ($V_R=400V$)

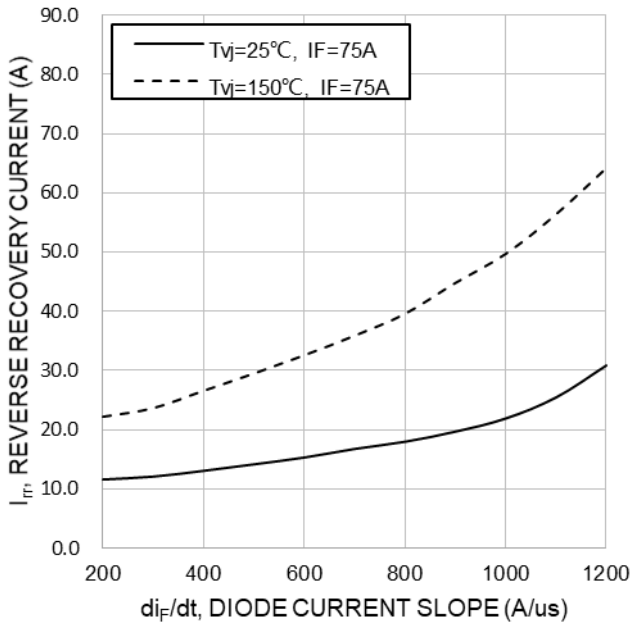

Fig. 13 Typical reverse recovery current as a function of diode current slope ($V_R=400V$)

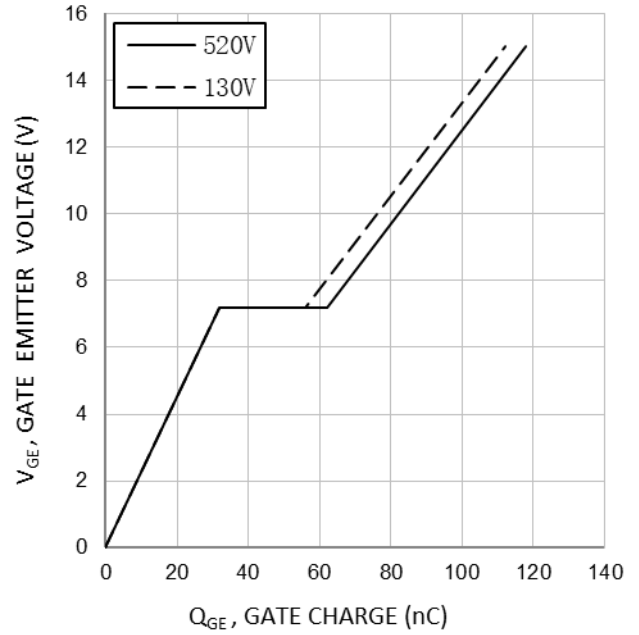

Fig. 14 Typical gate charge ($I_c=75A$)

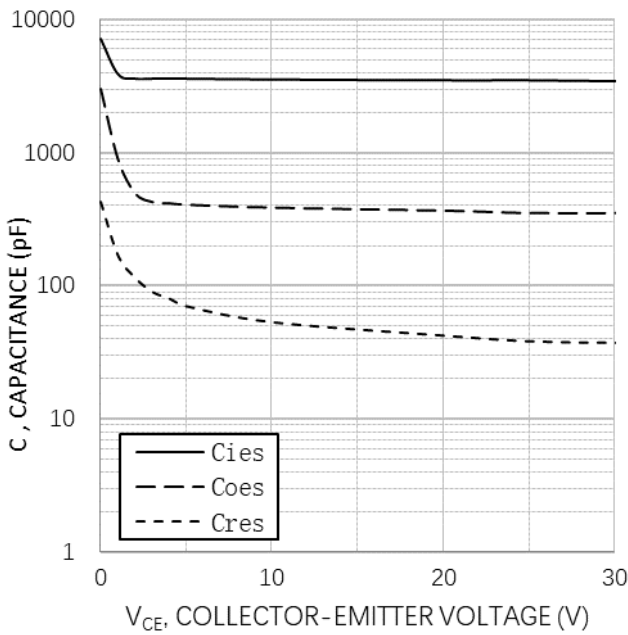

Fig. 15 Typical capacitance as a function of collector-emitter voltage ($V_{GE}=0V, f=1MHz$)

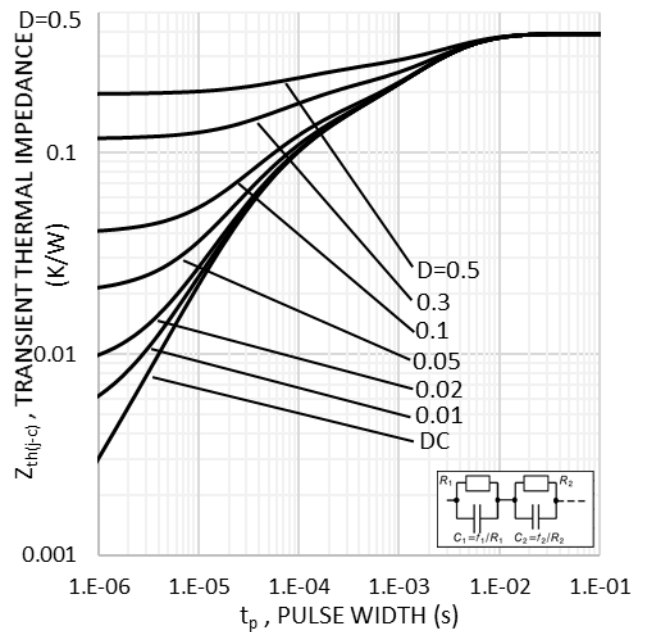
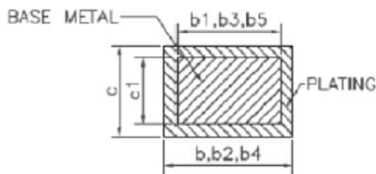
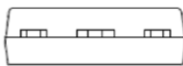
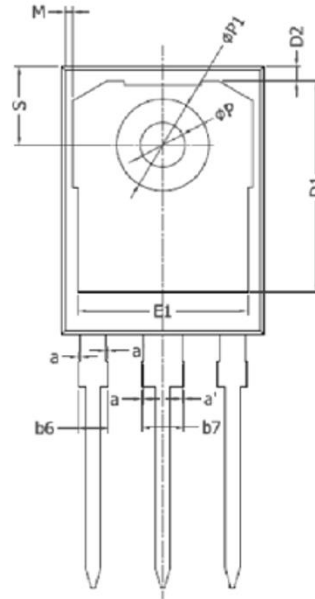
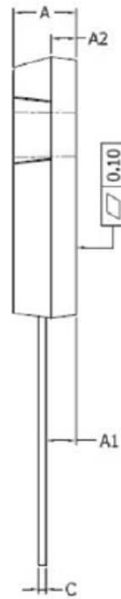
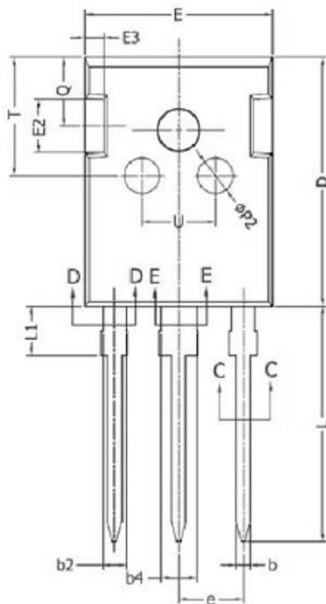

Fig. 16 IGBT transient thermal impedance ($D=t_p/T$)

Package Information

TO-247-3L



SECTION C-C, D-D & E-E

SYMBOL	MIN	NOM	MAX
A	4.90	5.00	5.10
A1	2.31	2.41	2.51
A2	1.90	2.00	2.10
a	0	---	0.15
a'	0	---	0.15
b	1.16	---	1.26
b1	1.15	1.2	1.22
b2	1.96	---	2.06
b3	1.95	2.00	2.02
b4	2.96	---	3.06
b5	2.96	3.00	3.02
b6	---	---	2.25
b7	---	---	3.25
c	0.59	---	0.66
c1	0.58	0.60	0.62
D	20.90	21.00	21.10
D1	16.25	16.55	16.85
D2	1.05	1.17	1.35
E	15.70	15.80	15.90
E1	13.10	13.30	13.50
E2	4.40	4.50	4.60
E3	1.50	1.60	1.70
e	5.436 BSC		
L	19.80	19.92	20.10
L1	---	---	4.30
M	0.35	---	0.95
P	3.40	3.50	3.60
P1	7.00	---	7.40
P2	2.40	2.50	2.60
Q	5.60	---	6.00
S	6.05	6.15	6.25
T	9.80	---	10.20
U	6.00	---	6.40